

LED STRIP NEONICA - RGB 5050 - 150 - 12V

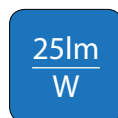

FEATURES

- Equal light output of each LED
- LED lifespan over 100 000 hours
- LED strip to decorative and accent applications
- Double thick reinforced FPC background
- Each production batch is laboratory tested
- Double-sided adhesive tape (IP20 & IP65)
- Product environmentally friendly - meets RoHS
- Made and designed in Poland
- 3 year warranty

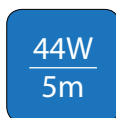

LED/m	Cutting unit	DC	W/m	Colour
30 qty	100 mm (3 LED)	12V	7,2W	RGB Mixed: red, green, blue

Protection class	Colour
IP 20	RGB
IP 65	RGB
IP 68	RGB
lm/m	150 - 180

Protection class:

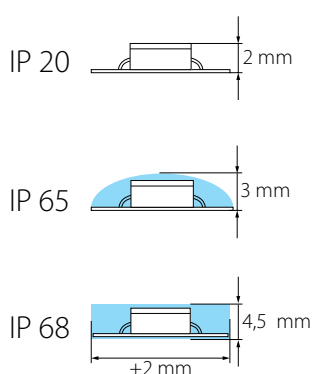

Cutting unit:

